

VOVO

ENGLISH
FRENCH
SPANISH

User Manual

TCB 8200SA / TCB 8200SA(Black)
TCB 8200S / TCB 8200S(Black)

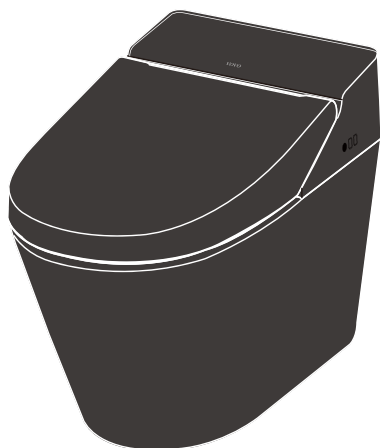
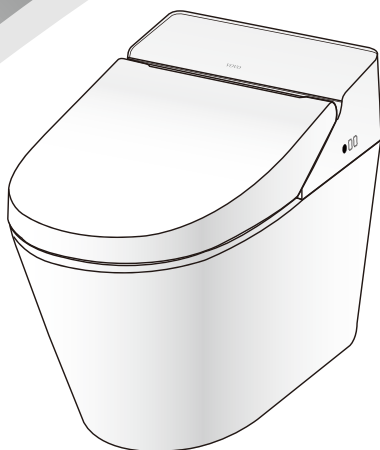

Contents

Preparation

Cautions for Safety	2
Name of Parts	4

Installation method

Installation method	5
Preparation and Check before Use	8

How to use

Proper Usage	10
Remote Control	11
How to use	17

Others

Maintenance	20
Troubleshooting	22
Customer Support	26
Specifications	27
Warranty	28

To our customers

- Thank you for choosing our bidet.
- For your own safety, please read this user manual carefully.
- Please refer to this manual if you have any questions while in use.
- We are not responsible for the accidents from the end user' s carelessness.
- Product warranty is included in this manual. Be careful not to lose it.

Cautions for Safety

Read all instructions before installation and use.

This manual contains important precautions and operating instructions for your own safety.



Danger The following points indicate an imminently hazardous situation which, if not avoided, will result in death or serious injury.

This is an electric appliance. Do not install the product in a place where the product is exposed to splash of water or humidity such as dew formation. When installing the product in the bathroom with bathtub, install ventilator to facilitate ventilation.



Prohibited

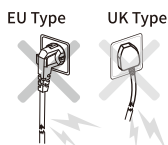

Do not use damaged cord, plug, consent and do not connect power while no water supply.

– It can cause short circuit, fire or electric shock.

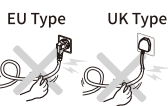

Handle power cord carefully and do not bend or pull it forcibly.

– It can cause fire or electric shock.

– It can cause water leakage from the main body of piping.

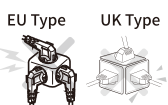

Do not use loose or unstable outlet and do not exceed the rated voltage of the outlet or the distributor.

– It can cause fire or electric shock.



Do not step on, shock, or place heavy objects on the seat, cover, or main body.

– You can hurt yourself.

– It can cause breakage or damage.

– It can cause water leakage through broken toilet.



Do not spray water



Do not splash water or detergent on the main body or power plug.

– It can cause fire or electric shock.



Wet hand prohibited

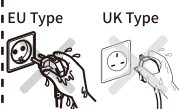

Do not touch the power cord with wet hands.

– It can cause electric shock.



Fire prohibited



Do not place fire such as cigarette near the product.

– It can cause fire, electric shock or injury.



Do not disassemble



Do not open the product to repair or remodel.

Only qualified service person should service this product.

– It can cause fire, electric shock or malfunction.



Grounding

■ **Make sure the product is properly grounded.**

– If the product is not grounded, it can cause electric shock or electric leakage.

– For grounding work, consult an electric technician nearby.



Observe strictly

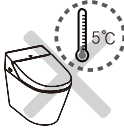

Do not use damaged cord, plug, consent and do not connect power while no water supply.

– It can cause short circuit, fire or electric shock.



When installing the strainer, connect it tightly.

– Otherwise, it can cause water leakage.
– When water leaks, close the shutoff valve to stop water supply. (Turn the valve clockwise with screwdriver.)



Do not place hand or clothes on the warm air outlet.

– It can cause burn, electric shock or fire.

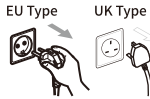

Unplug the main power cable when you fix it.

– It can cause electric shock.

■ **Do not use industrial water or graywater for water supply.**

– It can cause dermatitis.
– It can cause malfunction because of pollutant in water.



Warning

The following points indicate dangerous situations where the user could suffer or sustain material damages if this product is used incorrectly.

Do not use for other purposes than reported in this manual.



Prohibited



Do not throw in anything else in the toilet except toilet paper.

– Toilet can be clogged and it can cause the backflow of wastewater.
– Be careful not to drop anything into the toilet bowl.



Observe strictly



Make sure urine doesn't splash on to the nozzle and outlet of air vent.

– It can cause stinky odor and malfunction.



When cleaning, use mild detergent with soft cloth and do not use the following (bathroom detergent, household detergent, benzene, paint thinner, nylon scrubber)

– It can cause breakage.

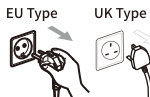

Unplug the main power cable when not using the product for a long time.

– It can cause malfunction.

- There is concern in minor burns with heated seat.
- Anti-burning system will operate when the user is sitting on the seat for a long time.
- Turn off the seat temperature when the user is sitting on the seat for a long time.
- Turn off the seat temperature and dry temperature in the following cases.
 - Children, Seniors, and People who can't control the product.
 - Patients and disabled people.
 - People who take sleeping pills or medicine.
 - People who are drunk or exhausted.

Names of Parts

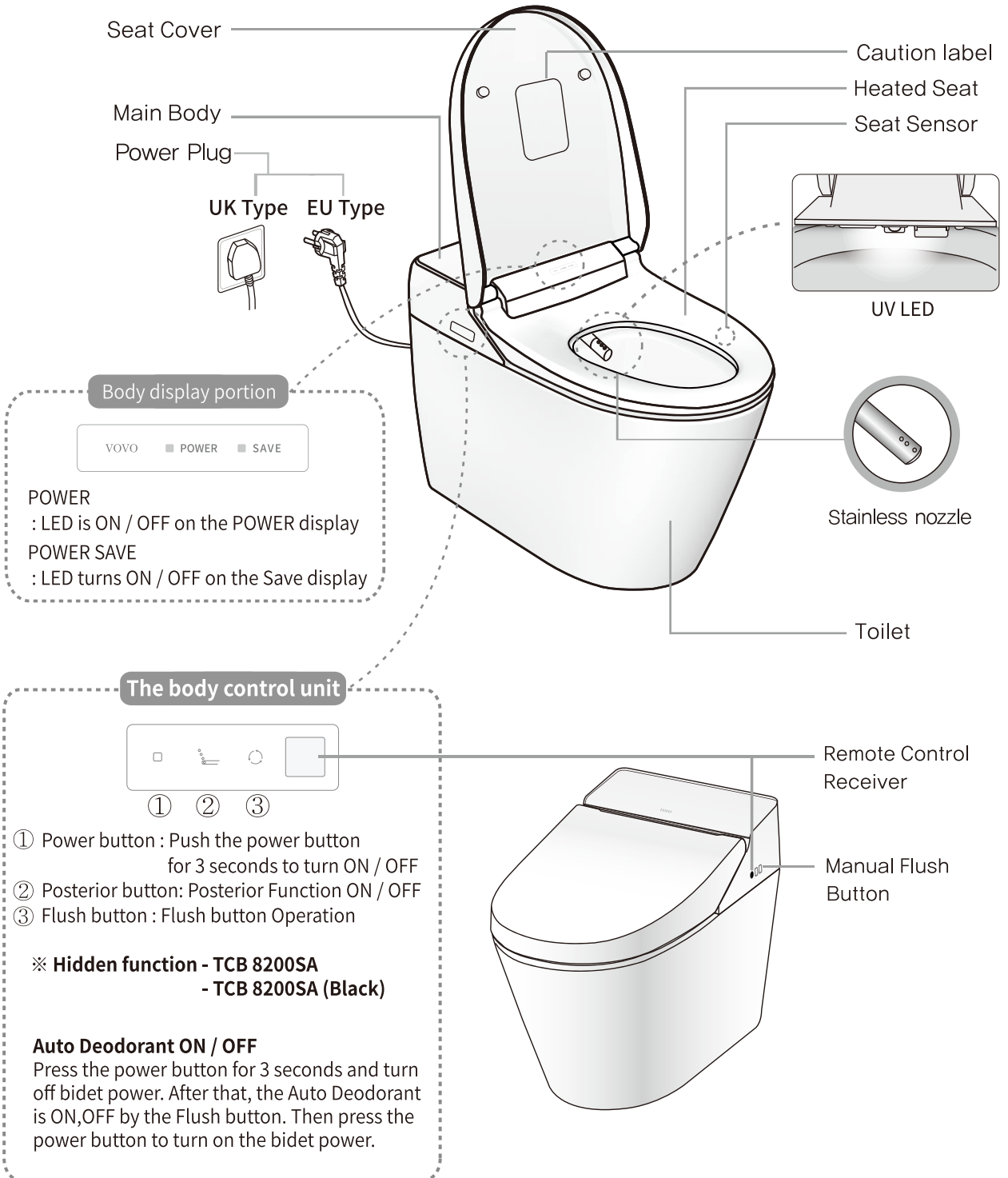

Installation Method

The below images may be different with the actual products.

1 Cautions before Installation (This may differ from the product specification.)

- Installation Space**
- Secure enough installation space in the bathroom and check whether it disturbs the bathroom door.
 - Secure water outlet at least 100mm away from the floor.
 - It can cause the discoloration of wall.
 - Check whether the water supply pipe and drain pipe are in the required position before installation.

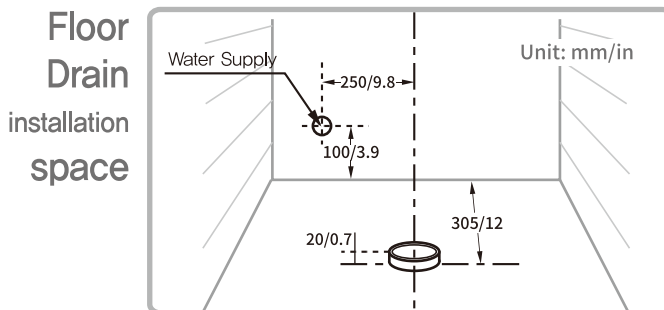

- Water Pressure**
 - Minimum 1.5 kgf/cm² (0.15 MPa) water pressure is required. If the pressure is not secured, please be aware that the flushing may not work properly to discharge the dirt.
 - Even if other modifiers are used at the same time, it still requires more than the minimum required water pressure. The maximum water pressure is 7.5 kgf/cm² (0.75 MPa).

Open the valve as much as possible. If it meets the following, you can secure the minimum required water pressure. Water supply of 3.5L or up for 10 seconds.

Let the water out for 10 seconds to check the amount. Prepare a bucket.

How to check the minimum water pressure

If you do not have the pressure meter, check the pressure as illustrated on the right.

2 Accessories (This may differ from the product specification.)

Remote control & Bracket (double-sided tape is included)
Each product may use a different remote controller.



Remote control

Wall Mount



Battery



Screw(Optional)



Plastic anchor(Optional)

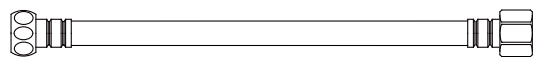

Water Hose (1m)



Ring Plate

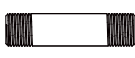

Water Pipe



Water Shutoff Valve(Optional)

* This may differ from the product specification.

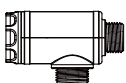

Water filter(Strainer) (Optional)

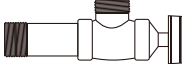

Water Closing Valve

Drain parts

* ①, ② one of these will be included.

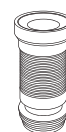

① Drain pipe



② Trap

3 Installation (This may differ from the product specification.)

1 Installation Accessories

1. Close the water gauge.
2. Remove dust and sand in the water inlet when installing the shutoff valve.
3. Connect the pipe with the shutoff valve.
4. Connect the Strainer Filter.

※ Please do not connect like below ※

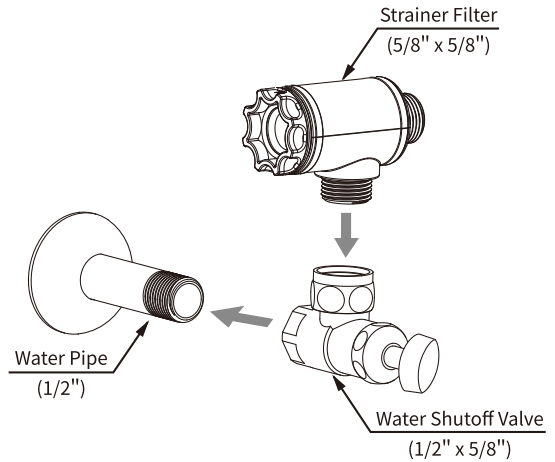
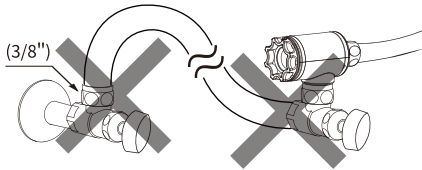

Install with a trap

2 Install drain pipe

- Combine (fix) the drain pipe at the bottom of the product.
- 220 – 400mm is possible from the bottom rear end to the center of the floor connection drain pipe

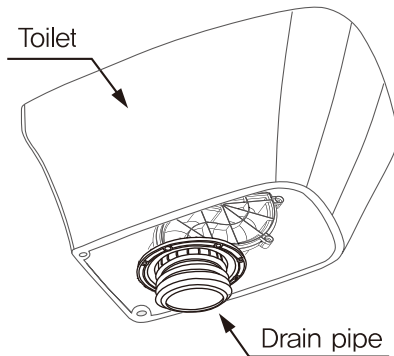

Install with a drain pipe

3 Connect drain pipe

- Connect (fix) the drain pipe to the bottom for the product.

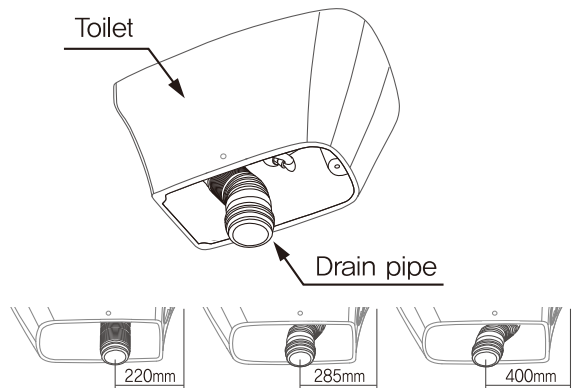

↑ 220 – 400mm is possible from the bottom rear end to the center of the floor connection drain pipe.

4 Connect floor drain

▶ When installing floor pipe ▶

- Connect the bottom of the product where the drain pipe is coupled (fixed) to the PVC drain on the bathroom floor.
- Adjust the height of the PVC drain to 20mm from the floor so that it is level.
- ※ After painting a lot of soapy water around the drain pipe rubber packing, insert the drain pipe rubber packing deeply into the PVC drain hole on the floor.

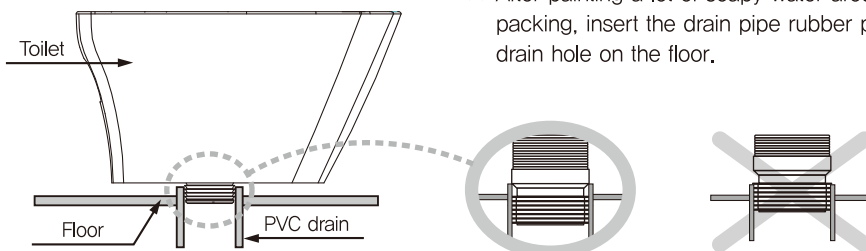

5 Connect Hose

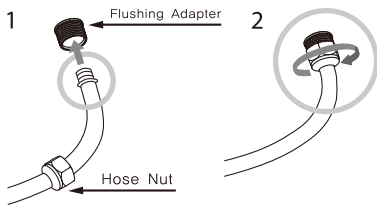

1. Fix the hose to the flushing adapter first.
2. Turn the nut clockwise to connect the hose.

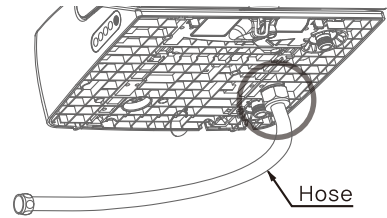

6 Connect Bidet to Toilet

1. Assemble the toilet with bidet, jet spray outlet and bowl washing outlet.
2. Insert the hose into the filter.
3. Insert bidet's fixing hook onto the toilet's fixing hook until it "clicks".

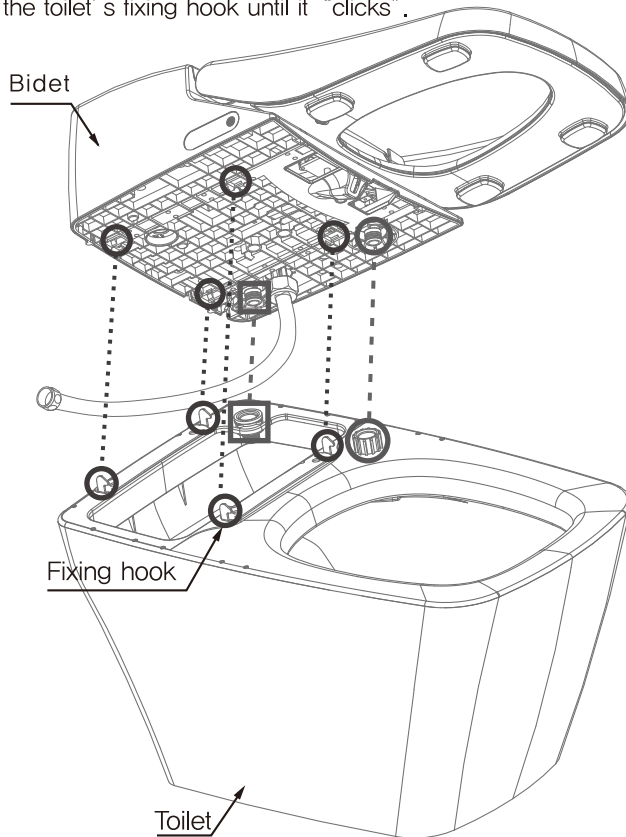
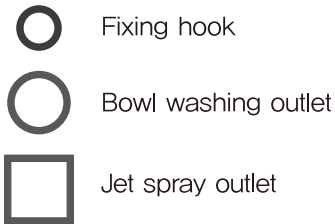

Strainer Filter

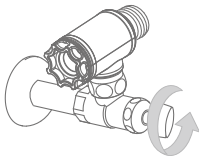
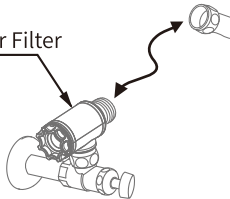

- Open the water shutoff valve.

7 Connect Power

1. Insert the power plug into the outlet.
2. Press the Flush button,
– Water will fill the ceramic bowl.

1. EU Type

UK Type

2.

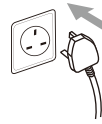
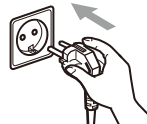

※ The water may overflow out of the rim when cleaning the bowl in the region with high water pressure.

Using a screwdriver, turn the shutoff valve clockwise to reduce the water pressure.

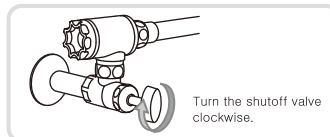

Turn the shutoff valve clockwise.

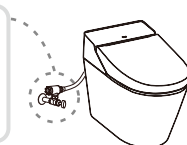

Preparation and Check Before Use

Preparation

1 Place the battery into the remote control

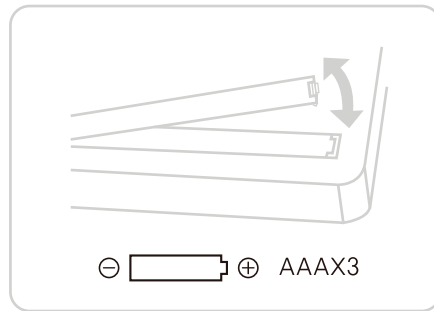

Advice 1

- ① Hold it on both sides and lift up.
- ② Open the battery cover on the back.
- ③ Put 3 AAA batteries in order. (Included)
- ④ Close the cover

About the battery

● Observe the following to prevent breakage or leakage of fluid.

- Use the same type of batteries when to replace old batteries
- Remove batteries when not used for a long time.
- Do not use rechargeable batteries

Sometimes the settings (temperature, auto flush) are initialized after replacing batteries. Configure the settings again.

2 Check if the power plug is connected

EU Type UK Type

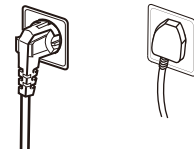

Advice 1 Turn off the power on the main body when replacing batteries or cleaning the product.

3 Adjust water flow with the shutoff valve

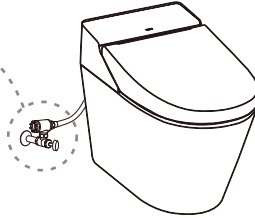
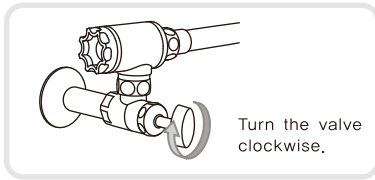

If the water pressure is too high, water may splash or overflow when flushing the toilet. Turn the water shutoff valve clockwise to reduce pressure.

Check

4 Check the display panel

- Is the operation lamp on?



If not on, press the Power button

Power button

to turn on the lamp.



VOVO POWER SAVE

- After plugging in the power plug, check that the power display panel is on.

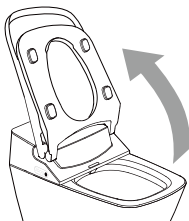

- Please open the seat and the lid when you reset the bidet toilet

Proper Usage

- Preserve the environment with power and water saving mode

- Preserve the environment with power and water saving mode
- Turn on the power saving mode.
 - Adjust Water Temperature and Seat Temperature to a mild level.

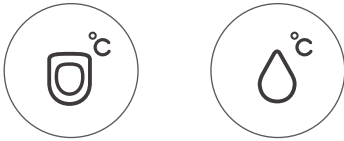

- Turn off the power when not using the product for a long time.
 - Press the 'Power' or 'Stop' button for 3 seconds to turn off the power.

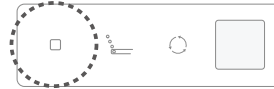

- Close the seat cover.
 - Close the seat cover to save power, and keep the heat on the seat surface stable.



- Do not expose the product to direct sunlight.
 - It can cause the discoloration of product.
 - The heat on the seat surface will become unstable.

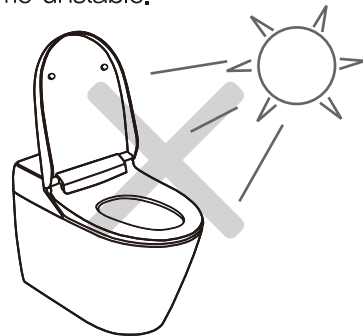

- Drain off the water from the water tank when not using the product for a long time, or when moving the product to another place.
 - It can cause water pollution and the leakage during transportation.

1.

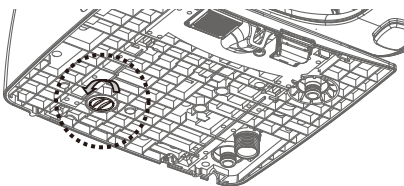

2.

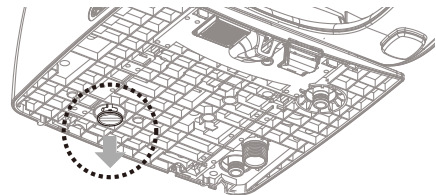

Remote Control

- TCB 8200SA
- TCB 8200SA (Black)

〈 TOP 〉



Flush (Full. Small) Button

- Press the flush button to activate the full or small flush.

Cover and Seat Opening

- When you press the cover or toilet seat buttons, both the toilet seat cover and the toilet seat are automatically open and closed.

Power Save On / OFF (Hidden function)

- Power save function is activated by pressing the auto lid open/close button for 2 seconds
- In power save mode, water temperature, and seat temperature will be adjusted efficiently when not used for more than one hour.
- When the product is used again, the temperature returns back to the original setting.

Seat Cover Opening/Closing

- Press the seat cover button to automatically open and close the toilet seat cover

Auto Lid Open / Close

- When you stand in front of the toilet, the lid automatically opens, and when you move away from the toilet, the lid automatically closes.

Nozzle Cleaning (Hidden function)

- Press the 'Auto flush' button for 2seconds to activate the nozzle cleaning function.
- When you press the nozzle cleaning button, the nozzle comes forward.

Seat Cover and Seat Closing

- Press the close button to close both the toilet seat cover and toilet seat.

Auto Flush ON/OFF

- The seat sensor detects user's seating and flushes automatically by differentiating large and small flushes based on user's seated time.
(Less than 2mins, small flush / more than 2 mins, large flush)

〈 Front 〉

Stop

- To stop the function being used, press the STOP button.

Posterior/Rhythm

- Performs Posterior wash(Back area of the body) by pushing the button once.
- Performs Rhythm function when pushed the button again while the posterior function is on the process.
- During Rhythm function, the nozzle will move to wash wide area and provide pulsating massage effect with changing water pressure.

Feminine/Rhythm

- Performs Feminine wash(Frontal area of the body) by pushing the button once.
- Performs Rhythm function when pushed the button again while the feminine function is on the process.
- During Rhythm function, the nozzle will move to wash wide area and provide pulsating massage effect with changing water pressure.

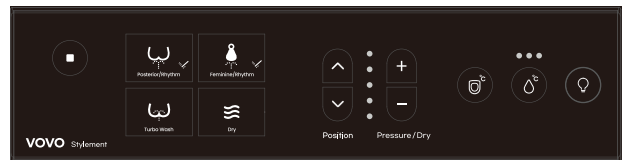
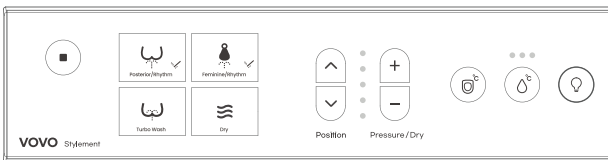

Turbo Wash

- Press the Turbo Wash button to activate washing water spray from the nozzle.

Pressure / Dry

- It is possible to adjust the water pressure of Posterior wash, Feminine wash, and Turbo wash in five steps.
- The temperature of the drying function can be adjusted in three steps.

UV LED Light ON / OFF

- UV LED eliminates germs and bacteria as well as sterilizing the bowl.
- When UV LED function is activated, UV LED will turn on and it will automatically turn off while seated.

Dry

- Dry off the water after using the posterior Wash, Feminine Wash, and Turbo Wash function.
- It takes time to dry completely.

Seat Temp

- The toilet seat temperature button can adjust the temperature of the toilet seat in three steps.

Position

- The nozzle position can be adjusted in five steps.

Water Temp

- It is possible to adjust the water temperature of Posterior wash, Feminine wash, and Turbo wash in three steps.

- TCB 8200SA
- TCB 8200SA (Black)

< DESSUS >



Bouton (petite/grande) chasse d'eau

Appuyez sur le bouton de la chasse d'eau afin d'actionner la petite ou la grande chasse.

Ouverture du couvercle et du siège des toilettes

- Lorsque vous appuyez sur les boutons du couvercle ou du siège des toilettes, le couvercle et le siège s'ouvrent et se ferment automatiquement.

Mode d'économie d'énergie (Fonction cachée)

- La fonction d'économie d'énergie est activée en appuyant sur le bouton d'ouverture/fermeture automatique du couvercle pendant 2 secondes
- En mode d'économie d'énergie, la température de l'eau et celle du siège se règlent de manière efficace lorsqu'elles ne sont pas utilisées pendant plus d'1h.
- Lorsque les toilettes sont utilisées de nouveau, la température revient au réglage initial.

Ouverture/Fermeture du couvercle des toilettes

- Appuyez sur le bouton « DESSUS » afin d'ouvrir et de fermer automatiquement le couvercle des toilettes.

Ouverture/Fermeture automatique du couvercle

- Le couvercle s'ouvre automatiquement lorsque vous vous tenez debout devant les toilettes. Et il se ferme automatiquement lorsque vous vous éloignez des toilettes.

Nettoyage de la buse (Fonction cachée)

- Appuyez sur le bouton 'Auto flush' pendant 2 secondes pour activer la fonction de nettoyage de la buse.
- Lorsque vous appuyez sur le bouton de nettoyage de la buse, la buse avance.

Fermeture du couvercle et du siège des toilettes

- Appuyez sur le bouton « Fermeture » afin de fermer à la fois le couvercle et le siège des toilettes.

Chasse d'eau automatique marche /arrêt

- Cette fonction distingue l'urine des matières fécales.

< DEVANT >

Stop

- Afin de stopper le fonctionnement en cours, appuyez sur le bouton « Stop ».

Postérieur/Nettoyage à impulsions

- Appuyez une fois sur le bouton afin d'effectuer le nettoyage du postérieur (zone arrière du corps).
- Pour effectuer le nettoyage à impulsions, appuyez de nouveau sur le bouton pendant que le nettoyage du postérieur est en cours.
- Durant le nettoyage à impulsions, la buse se déplace afin de nettoyer largement la zone et offre un effet de massage à impulsions en changeant la pression de l'eau.

Nettoyage de la zone intime de la femme

- Zone intime de la femme/Nettoyage à impulsions
- Appuyez une fois sur le bouton afin d'effectuer le nettoyage de la zone intime de la femme (zone frontale du corps).
- Pour effectuer le nettoyage à impulsions, appuyez de nouveau sur le bouton pendant que le nettoyage de la zone intime est en cours.
- Durant le nettoyage à impulsions, la buse se déplace afin de nettoyer largement la zone et offre un effet de massage à impulsions en changeant la pression de l'eau.

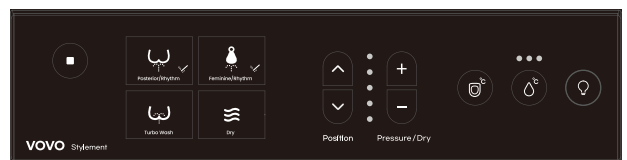

Nettoyage turbo

- Appuyez sur le bouton « Nettoyage turbo » afin d'activer le jet d'eau permettant de vous laver à partir de la buse.

Séchage

- Il est utilisé pour sécher l'eau après avoir utilisé le lavage postérieur, féminin et turbo.
- Il faut du temps pour sécher complètement.

Position

- La position de la buse est réglable sur 5 niveaux.

Pression / Séchage

- Il est possible de régler la pression de l'eau sur 5 niveaux pour le nettoyage du postérieur, de la zone intime de la femme et du nettoyage turbo.
- La température de la sècheuse peut être contrôlée en trois étapes en appuyant sur le bouton pression d'eau/séchage +, - pendant l'utilisation de la sècheuse.

Température du siège

- Le bouton « Température du siège » vous permet de régler la température du siège sur 3 niveaux.

Température de l'eau

- Il est possible de régler la température de l'eau sur 3 niveaux pour le nettoyage du postérieur et de la zone intime de la femme, ainsi que pour le lavement.

Lumière LED UV marche/arrêt

- La fonction UV LED Light est activée en appuyant sur le bouton de rinçage automatique pendant 2 secondes
- La LED UV tue les germes et les bactéries et stérilise le bol.
- Lorsque les fonctions de la lumière LED d'UV est activée, celle-ci va être allumée et s'éteint automatiquement lorsqu'on s'assoit.

Mando a distancia

SPANISH

- TCB 8200SA
- TCB 8200SA (Black)

〈Parte superior〉



Botón de descarga (completa - pequeña)

-Presione el botón de descarga para activar la descarga completa o pequeña.

Apertura de la tapa y del asiento

-Al presionar el botón de la tapa del asiento o del asiento del retrete, ambos se abren o se cierran de manera automática.

Ahorro de energía ON / OFF (función oculta)

- La función de ahorro de energía se activa presionando el botón de apertura/cierre automático de la tapa durante 2 segundos
- En el modo de ahorro de energía, la temperatura del agua y la temperatura del asiento se ajustarán de manera eficiente cuando no se utilicen durante más de una hora.
- Cuando el producto se utiliza de nuevo, la temperatura vuelve a la configuración original.

Apertura/Cierre de la tapa del asiento

-Presione el botón de la tapa del asiento del retrete para abrirla o cerrarla de manera automática.

Apertura/Cierre automático de la tapa

-Cuando se ubique delante del retrete o se aleje de este, la tapa se abrirá o cerrará respectivamente de manera automática.

Limpieza de la boquilla (función oculta)

- Botón de ahorro de energía de 'lavado automático' durante 2 segundos para activar la función de limpieza de la boquilla.
- Presione el botón de limpieza de la boquilla para limpiarla hacia el frente.

Cierre de la tapa y del asiento

-Presione el botón de cierre para cerrar tanto la tapa del asiento como el asiento del retrete.

Encendido/Apagado de la descarga automática

-El sensor del asiento detecta al usuario y descarga de manera automática diferenciando entre descargas grandes y pequeñas. Esto en función del tiempo que el usuario permanezca sentado.

〈Parte frontal〉

Detener

-Para detener la función que se está utilizando, presione el botón DETENER.

Posterior/Ritmo

- Realiza el lavado posterior (zona posterior del cuerpo) cuando se presiona el botón una vez.
- Realiza la función Ritmo cuando se presiona de nuevo el botón mientras la función posterior está activa.
- Durante la función Ritmo, la boquilla se moverá para lavar una zona amplia y generar un efecto de masaje pulsante con cambios en la presión del agua.

Femenino/Ritmo

- Realiza el lavado femenino (zona frontal del cuerpo) cuando se presiona el botón una vez.
- Realiza la función Ritmo cuando se presiona de nuevo el botón mientras la función femenino está activa.
- Durante la función Ritmo, la boquilla se moverá para lavar una zona amplia y generar un efecto de masaje pulsante con cambios en la presión del agua.

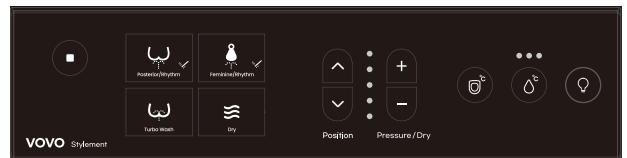
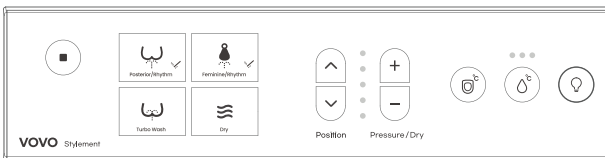

Lavado turbo

-Presione el botón de lavado turbo para activar el chorro de agua de lavado desde la boquilla.

Secado

-Seca el agua después de utilizar las funciones de lavado posterior, lavado femenino y lavado turbo.

Posición

-La posición de la boquilla puede ser ajustada en cinco niveles.

Presión / Secado

- Es posible ajustar la presión del agua del lavado posterior, lavado femenino y lavado turbo en cinco niveles.
- La temperatura de la función de secado puede ser ajustada en tres niveles.

Temperatura del asiento

-El botón de temperatura del asiento del retrete puede ajustar su temperatura en tres niveles.

Temperatura del agua

-Es posible ajustar la temperatura del agua del lavado posterior, lavado femenino y lavado turbo en cinco niveles.

Opción de encendido/apagado de la luz LED UV

- La luz LED UV elimina gérmenes y bacterias a la vez que esteriliza la taza.
- Cuando la función LED UV esté activada, el LED UV se encenderá, y se apagará de manera automática mientras esté sentado.

Remote Control

ENGLISH

- TCB 8200S
- TCB 8200S (Black)

< TOP >



Flush (Full. Small) Button

- Press the flush button to activate the full or small flush.

Nozzle Cleaning

- When you press the nozzle cleaning button, the nozzle comes forward.

Auto Flush ON/OFF

- Distinguishes between small flush and full flush based on the time the user is seated on the seat.

Auto Deodorant ON / OFF

- Press the deodorant button to remove the odor inside the bowl.

Power saving ON / OFF

- You can turn the power saving function ON / OFF feminine key. to save the unused time and electricity cost.

UV LED Light ON / OFF

- UV LED eliminates germs and bacteria as well as sterilizing the bowl.
- When UV LED function is activated, UV LED will turn on and it will automatically turn off while seated.

< Front >

Stop

- To stop the function being used, press the STOP button.

Posterior/Rhythm

- Performs Posterior wash (Back area of the body) by pushing the button once.
- Performs Rhythm function when pushed the button again while the posterior function is on the process.
- During Rhythm function, the nozzle will move to wash wide area and provide pulsating massage effect with changing water pressure.

Feminine/Rhythm

- Performs Feminine wash (Frontal area of the body) by pushing the button once.
- Performs Rhythm function when pushed the button again while the feminine function is on the process.
- During Rhythm function, the nozzle will move to wash wide area and provide pulsating massage effect with changing water pressure.

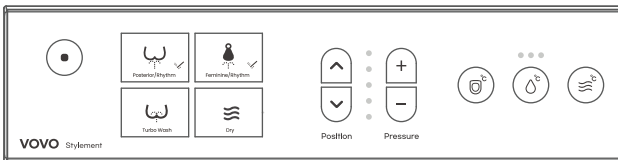

Turbo Wash

- Press the Turbo Wash button to activate washing water spray from the nozzle.

Dry

- Dry off the water after using the posterior Wash, Feminine Wash, and Turbo Wash function.
- It takes time to dry completely.

Position

- The nozzle position can be adjusted in five steps.

Pressure

- It is possible to adjust the water pressure of Posterior wash, Feminine wash, and Turbo wash in five steps.

Seat Temp

- The toilet seat temperature button can adjust the temperature of the toilet seat in three steps.

Water Temp

- It is possible to adjust the water temperature of Posterior wash, Feminine wash, and Turbo wash in three steps.

Dry Temp

- The temperature of the drying function can be adjusted in three steps.

Télécommande

FRENCH

- TCB 8200S
- TCB 8200S (Black)

< DESSUS >

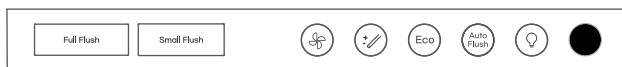

Bouton (petite/grande) chasse d'eau

Appuyez sur le bouton de la chasse d'eau afin d'actionner la petite ou la grande chasse.

Désodorisation automatique marche/arrêt

- Appuyez sur le bouton « Désodorisation » afin d'éliminer les odeurs émanant de l'intérieur de la cuvette.

Nettoyage de la buse

- Lorsque vous appuyez sur le bouton de nettoyage de la buse, la buse avance.

Mode d'économie d'énergie

- En mode d'économie d'énergie, la température de l'eau et celle du siège se règlent de manière efficace lorsqu'elles ne sont pas utilisées pendant plus d'1h.
- Lorsque les toilettes sont utilisées de nouveau, la température revient au réglage initial.

Chasse d'eau automatique marche/arrêt

- Cette fonction distingue l'urine des matières fécales.

Lumière LED UV marche/arrêt

- La fonction UV LED Light est activée en appuyant sur le bouton de rinçage automatique pendant 2 secondes
- La LED UV tue les germes et les bactéries et stérilise le bol.
- Lorsque les fonctions de la lumière LED d'UV est activée, celle-ci va être allumée et s'éteint automatiquement lorsqu'on s'assoit.

< DEVANT >

Stop

- Afin de stopper le fonctionnement en cours, appuyez sur le bouton « Stop ».

Postérieur/Nettoyage à impulsions

- Appuyez une fois sur le bouton afin d'effectuer le nettoyage du postérieur (zone arrière du corps).
- Pour effectuer le nettoyage à impulsions, appuyez de nouveau sur le bouton pendant que le nettoyage du postérieur est en cours.
- Durant le nettoyage à impulsions, la buse se déplace afin de nettoyer largement la zone et offre un effet de massage à impulsions en changeant la pression de l'eau.

Nettoyage de la zone intime de la femme

- Zone intime de la femme/Nettoyage à impulsions
- Appuyez une fois sur le bouton afin d'effectuer le nettoyage de la zone intime de la femme (zone frontale du corps).
- Pour effectuer le nettoyage à impulsions, appuyez de nouveau sur le bouton pendant que le nettoyage de la zone intime est en cours.
- Durant le nettoyage à impulsions, la buse se déplace afin de nettoyer largement la zone et offre un effet de massage à impulsions en changeant la pression de l'eau.

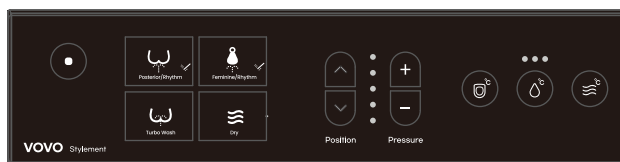
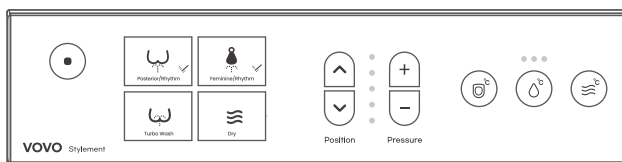

Nettoyage turbo

- Appuyez sur le bouton « Nettoyage turbo » afin d'activer le jet d'eau permettant de vous laver à partir de la buse.

Température du siège

- Le bouton « Température du siège » vous permet de régler la température du siège sur 3 niveaux.

Position

- La position de la buse est réglable sur 5 niveaux.

Température de l'eau

- Il est possible de régler la température de l'eau sur 3 niveaux pour le nettoyage du postérieur et de la zone intime de la femme, ainsi que pour le lavement.

Température du siège

- Le bouton « Température du siège » vous permet de régler la température du siège sur 3 niveaux.

Température de l'eau

- Il est possible de régler la température de l'eau sur 3 niveaux pour le nettoyage du postérieur et de la zone intime de la femme, ainsi que pour le lavement.

Température de séchage

- La température de séchage est réglable sur 3 niveaux.

Mando a distancia

SPANISH

- TCB 8200S
- TCB 8200S (Black)

〈Parte superior〉

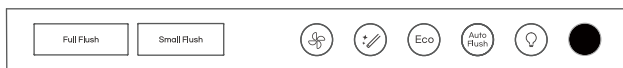

Botón de descarga (completa - pequeña)

-Presione el botón de descarga para activar la descarga completa o pequeña.

automático de desodorante ON / OFF

-Presione el botón de desodorante para eliminar el olor dentro del recipiente.

Limpieza de la boquilla

-Presione el botón de limpieza de la boquilla para limpiarla hacia el frente.

Risparmio energetico ON / OFF

-In modalità di risparmio energetico, la temperatura dell'acqua e la temperatura del sedile verranno regolate in modo efficiente quando non vengono utilizzate per più di un'ora.
-Quando il prodotto viene riutilizzato, la temperatura ritorna all'impostazione originale.

Encendido/Apagado de la descarga automática

-El sensor del asiento detecta al usuario y descarga de manera automática diferenciando entre descargas grandes y pequeñas. Esto en función del tiempo que el usuario permanezca sentado.

Opción de encendido/apagado de la luz LED UV

-La luz LED UV elimina gérmenes y bacterias a la vez que esteriliza la taza.
-Cuando la función LED UV esté activada, el LED UV se encenderá, y se apagará de manera automática mientras esté sentado.

〈Parte frontal〉

Detener

-Para detener la función que se está utilizando, presione el botón DETENER.

Posterior/Ritmo

-Realiza el lavado posterior (zona posterior del cuerpo) cuando se presiona el botón una vez.
-Realiza la función Ritmo cuando se presiona de nuevo el botón mientras la función posterior está activa.
-Durante la función Ritmo, la boquilla se moverá para lavar una zona amplia y generar un efecto de masaje pulsante con cambios en la presión del agua.

Femenino/Ritmo

-Realiza el lavado femenino (zona frontal del cuerpo) cuando se presiona el botón una vez.
-Realiza la función Ritmo cuando se presiona de nuevo el botón mientras la función femenino está activa.
-Durante la función Ritmo, la boquilla se moverá para lavar una zona amplia y generar un efecto de masaje pulsante con cambios en la presión del agua.

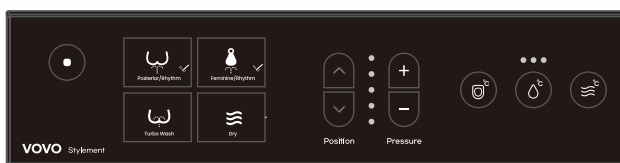
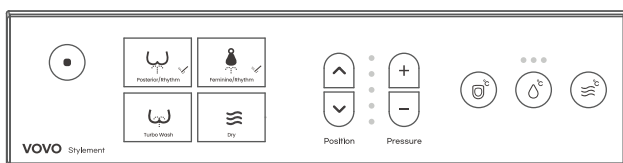

Lavado turbo

-Presione el botón de lavado turbo para activar el chorro de agua de lavado desde la boquilla.

Secado

-Seca el agua después de utilizar las funciones de lavado posterior, lavado femenino y lavado turbo.

Posición

-La posición de la boquilla puede ser ajustada en cinco niveles.

Presión

-Es posible ajustar la presión del agua del lavado posterior, lavado femenino y lavado turbo en cinco niveles.

Temperatura del asiento

-El botón de temperatura del asiento del retrete puede ajustar su temperatura en tres niveles.

Temperatura del agua

-Es posible ajustar la temperatura del agua del lavado posterior, lavado femenino y lavado turbo en cinco niveles.

Temperatura de secado

-La temperatura de la función de secado puede ser ajustada en tres niveles.

How to Use



1 Sit on the seat

- The seat lamp will turn on.
- It operates after being occupied

2 Press the flush button on the remote control

- Only needs to be done after the first time of installation
- Water will fill the toilet to an appropriate level.

3 POSTERIOR / RHYTHM / FEMININE / RHYTHM / TURBO WASH

Press posterior  or Turbo wash 

Press feminine 

Advice 1

- It works for 1 minute.

Advice 2

How to use Turbo wash  properly.

- Press Turbo wash , set the water spray to the center of anus.
- Control the water pressure.
- If you feel that the water has filled you up, push the water out by forcing the abdomen.

4 Press Stop

- Press stop to stop the operation of Posterior, Feminine, and Turbo wash.

5 Full Flush Small Flush

Press Flush

6 Press Dry



- It works up to 3 minutes.

7 Press Stop

◆ How to use it more comfortably ◆

Comfortable 1 Rhythm

Enjoy Oscillating and Pulsating all together.

-   Press the button to wash.
Posterior / Rhythm Feminine / Rhythm
- Press the button again to perform rhythm function.
- In rhythm function, nozzle will move to wash wide area and provide pulsating massage effect with changing water pressure.
- Press the button once more if you want to stop the rhythm function.

Advice 1 Do not sit on the edge, but toward the inside of seat.

Advice 2 Comfortable functions don't work with Turbo wash.
Turbo wash wash starts from the lowest water pressure.

Flushing

Remote control Toilet Flush

Press the button on the remote control.



Auto Flush

Pressing the automatic on/off button sets the automatic flushing function.



When the batteries are running down

- Press the flush button on the control panel of main body

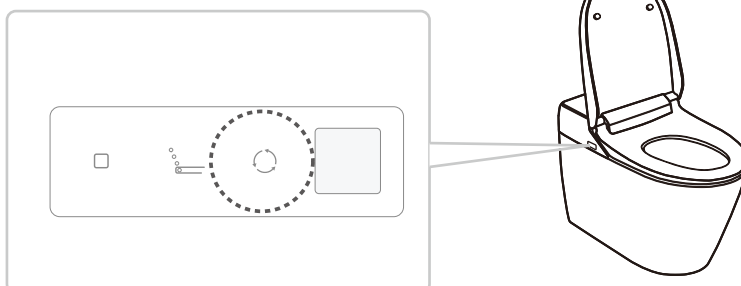

Cleaning the toilet when power is out

- Open the main body cover for toilet flushing.

 1. Press the Bowl cleaning button for 3 seconds
 2. Press the Flush button for 5 seconds.
 3. Press the Bowl cleaning button again for 3 seconds.

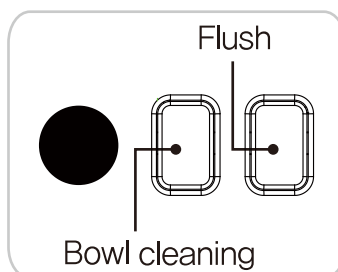

- ※ Bowl cleaning function is to clean the inner ceramic bowl.
- ※ Flush function is to jet high pressure water to flush down the soil in the bowl.

Open and Close the Toilet Seat and Lid TCB 8200SA / TCB 8200SA(Black)

There are 2 settings for opening and closing toilet seat and lid.
The remote controlled setting and the automatic setting.



Remote Controlled Open/Close of Toilet Seat and Lid

- The toilet seat and lid can be opened and closed by pressing the specific button on the remote control.

● Press the specific button on the remote controller.



The toilet seat and lid open and close

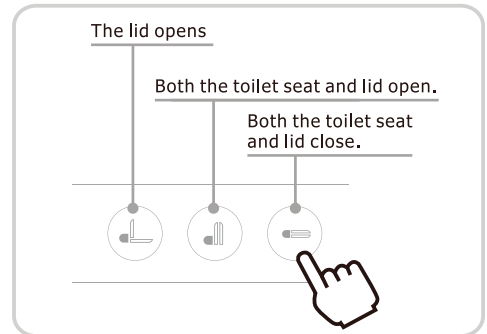

Automatic Open/Close of Toilet Seat and Lid

- When you stand in front of the toilet, the lid automatically opens, and when you move away from the toilet, the lid automatically closes.

* **Check** 'Auto lid open/close'

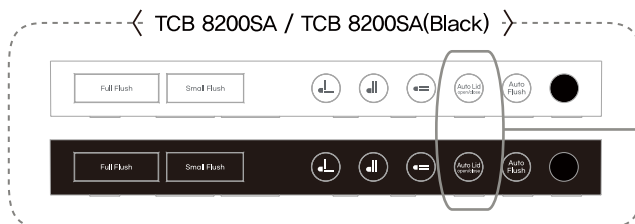

Auto Seat and Lid open/close butto

Maintenance

Caution

Make sure that auto flush function is turned off.
Please refer to the remote control/control panel pages.

Ordinary Maintenance

Maintaining the Main body, Seat and Lid.

- Wet a soft cloth
 - Clean with wet cloth. Advice 1-2
- When toilet detergent is stained
 - Wipe it with wet soft cloth.
- When cleaning the bathroom floor
 - If there are spots of urine around the toilet, wipe it with wet towel
- If the product is seriously contaminated
 - Wipe it with soft cloth and mild detergent.
 - Rough sponges, brushes make scratches on the surface of the product.
 - Do not use the following detergents

Prohibited

- Bath/toilet cleaning products
- Mold removable products
- Sink cleaning products
- Bleach
- Surfactant combined detergents

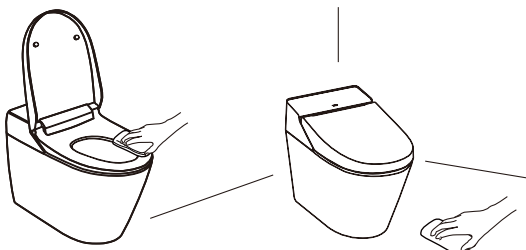

Advice 1

Tankless is an electric appliance.
Make sure water does not get into the product.

Advice 2

Keep the seat sensor, remote control transmitter and receiver clean. If sensors are not clean, the product may malfunction or will not function at all

Nozzle Cleaning

- Only the nozzle will extend out without spraying water.

1 Extend the nozzle



–TCB 8200SA /
TCB 8200SA(Black)
Check the Hidden
function nozzle cleaning
button on page 11

–TCB 8200S /
TCB 8200S(Black)



- Press nozzle cleaning button on the remote control or side control panel.
- The nozzle will extend out.

2 Clean the nozzle

- Use soft cloth or toothbrush to clean the nozzle.
- ※ Do not pull out or push the nozzle by force. It may cause breakage or trouble

3 Return the nozzle



–TCB 8200SA /
TCB 8200SA(Black)

Check the Hidden
function nozzle cleaning
button on page 11

–TCB 8200S /
TCB 8200S(Black)



- Press Nozzle cleaning button again.
- The nozzle moves back.

- ※ The nozzle will clean itself while it moves back
- ※ Do not push the nozzle.
- It may cause breakage or trouble.

Other Maintenance

Clean Strainer – This method could be different depending on the product specifications.

- If you feel the flushing becoming weak, clean the strainer.

1 Close the shutoff valve

- Turn the handle right to close the shutoff valve

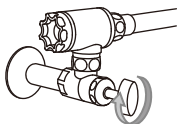

Attention



Prohibited

- Do not separate the strainer while the valve is open.
- Water will pour out.

2 Press the flushing button.

- Make sure that there is no water pressure on the body, hoses, and the strainer when flushing.

Full Flush

or



- ※ If you try to remove the strainer when there is still water pressure, water would be sprayed out due to pressure difference.

3 Disassemble the strainer

- Turn the strainer left to disassemble

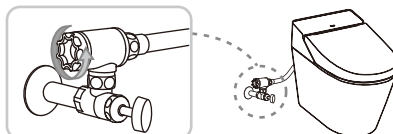

4 Clean the strainer

- Clean the strainer with water thoroughly to remove the dregs

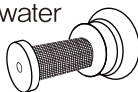

- ※ Use a tooth brush to remove small particles thoroughly.
- ※ Use scrubber to remove the dust particles or dregs inside the shutoff valve.

Advice 1

5 Replace the strainer

- turn the strainer right

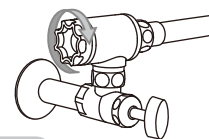

Attention



Comply strictly

- Make sure to screw up tightly.
- If not, it may leak.

6 Open the shutoff valve

- Turn the handle left to open the shutoff valve
- ※ check whether the water leaks from the shutoff valve.

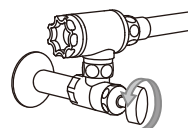

- Advice 1** **Cleaning the mesh** – Do not use detergent, but use water only.
– Do not apply excessive force to the strainer. It may deform the part.

Troubleshooting

- If you think the product is out of order, please refer to the following first.
- If the problem is still not solved, then contact local dealer or service center.
- Please unplug the power cord when requesting for repair service

When the water leaks, close the shutoff valve and stop the water supply. Turn the handle right.

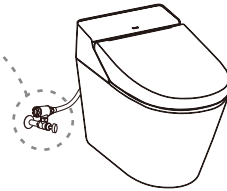
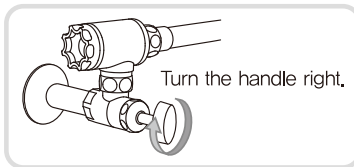







- Check the following before requesting for repair service.

Power supply

Trouble	Possible Causes	Solution
The unit is not working.	Isn't the power out or isn't the circuit breaker off?	Wait until the power is restored. Or turn on the circuit breaker.
	Isn't the operation lamp on the display panel of the main body off?	Turn on the power  Power in the control panel of the main body.

Posterior wash, Feminine wash, Turbo Wash

Trouble	Possible Causes	Solution
Water is not spraying out.	Isn't the water supply suspended?	Wait until the water supply is resumed.
	Isn't the shutoff valve closed?	Open the valve.
	Isn't the human body out of the location of seat sensor?	Refer to the Seat Sensor part.
	Isn't the hose twisted?	Loosen the hose.
Water pressure is weak.	Isn't the water pressure set to low level?	Adjust the water pressure to higher level.
	Isn't the strainer clogged?	Clean the strainer.

Trouble	Possible Causes	Solution
Water is cold.	Isn't the temperature set to a low level? Or is it turned off?	Adjust with  on the remote control.
	Isn't it in power saving mode?	The water temperature is set lower, the temperature goes up after sitting.
Water stops in the middle of cleansing.	Press one of  /  /  buttons, then it will stop automatically in 1 minutes.	Press the  /  /  button again.
	Isn't the human body out of the location of seat sensor?	Refer to the location of Seat Sensor on page 4.
The water flows into toilet for a few seconds near the nozzle when sitting on the toilet.	When the seat sensor is on, it releases some water before spraying. Or if you change position while seated, the sensor will turn on and off and release some water, it is not a malfunction.	—

Heated Seat

Trouble	Possible Causes	Solution
The seat is not warm.	Isn't the seat temperature set to low level?	Adjust seat temperature with  buttons on the remote control.
	Isn't it in power saving mode?	Sit on the seat and wait for about 5 minutes.
The seat is cold.	The heater turns off automatically 1 hour after you sit on the seat. When you stand up, the heater will turn on again.	—

Auto Flushing

Trouble	Possible Causes	Solution
Auto flushing is not working.	Isn't the auto flushing turned off? (When off, the flushing indication on the remote control display panel is off)	Press auto flushing  button on the remote control again to turn it on

Seat Sensor

Trouble	Possible Causes	Solution
The posterior wash or deodorant function works without sitting on the seat.	Isn't the seat sensor blocked with wet towel?	Remove the wet towel.
	Is the seat sensor wet?	Wipe out the water with dry cloth.

Deodorization

Trouble	Possible Causes	Solution
Deodorization is not working at all.	Isn't the human body out of the location of seat sensor?	Refer to the location of Seat Sensor on page 4.
Deodorization is not working at all.	Is the lamp on the main body on?	Set the deodorant function. -TCB-8200SA main unit control part hidden function Refer to page 4. -TCB-8200S remote control button See page 14.



Power Saving

Trouble	Possible Causes	Solution
Power saving is not working.	Isn't it unplugged? Didn't you change batteries?	Reset the setting by pushing the power saving button from the control panel -TCB-8200SA main unit control part hidden function Refer to page 11. -TCB-8200S remote control button See page 14.

Remote Control

Trouble	Possible Causes	Solution
Remote control is not working.	Aren't the batteries running down?	Replace old batteries with new ones.
	Aren't the polarities of batteries misplaced?	Insert batteries in order.
	Aren't the transmitter, receiver of the remote control blocked?	Remove the objects blocking transmitters.
	Aren't the transmitter, receiver of the remote control contaminated?	Wipe out the dust or water stain.
	Isn't human body out of the location of seat sensor?	Refer to the location of seat sensor on page 4.

Drying

Trouble	Possible Causes	Solution
Drying air temperature is low.	Isn't the air temperature set to a low level?	Adjust the air temperature with  buttons on the remote control.
The air blow stops in progress.	Press  then it will stop automatically after 3 minutes.	Press  again.

Drying

Trouble	Possible Causes	Solution
The air blow stops in progress.	It may stop if user changes his position while sitting.	Refer to the location of Seat Sensor on page 4.
The warm air drying function is not working at all.	Isn't the human body out of the location of seat sensor?	Refer to the location of Seat Sensor on page 4.

Flushing by Remote Control

Trouble	Possible Causes	Solution
I can't flush the toilet with remote control.	Aren't the batteries running down?	Replace old batteries with new ones.
	Didn't you press the button consecutively?	This function cannot be used consecutively. You will need to wait for about 10 seconds for next flush.
	Aren't the transmitter areas of remote control contaminated?	Clean the dust or water stain.

Others

Trouble	Possible Causes	Solution
The soil is not completely flushed down.	Is the shutoff valve opened enough?	Open the shutoff valve sufficiently.
	Isn't the strainer in the shutoff valve clogged?	Clean the strainer.
	Aren't you using water in other places than the bathroom?	—
The flushing water is not supplied.	Isn't the shutoff valve closed?	Open the shutoff valve sufficiently.
	Isn't the water supply suspended?	Wait until the water supply is resumed.
Water is leaking from the pipe joint.	Isn't the screw on the joint loosened?	Tighten the screw with a screwdriver.
When the automatic opening/closing function does not work (for TCB-8200SA)	Is the automatic opening/closing function off?	Press the automatic opening/closing button on the remote control to set it to ON. If it does not work after setting, remove the power plug for 5 minutes and connect it again with the toilet seat and seat cover open.

Customer Support

Before requesting for repair service, please check <Troubleshooting>

● Limited Warranty

- This manual includes the Warranty. Please complete the appropriate information (distributor, installation date) and read the Warranty carefully.
- The warranty period is 1 year from purchase date.

● Minimum storage period of replacement parts for repair use

- The minimum storage period of replacement parts for repair is 6 years from the completion of manufacture.

● In case of requesting for repair under warranty

- Please read the manual carefully again, and if there are still troubles, contact your local dealer or service center.
- Please submit the warranty card when requesting for repair service.

Information needed when requesting for repair

- | | |
|-------------------------------------|---------------------|
| - Address, name, telephone No. | - Product name |
| - Desired date for repairer's visit | - Serial Number |
| | - Installation Date |

● In case of requesting for repair after warranty

- Please contact local dealer or service center.
In case the product's function can be maintained by repair, we will provide pay repair service upon request.

Detail of repair charge (When requesting for customer service)

The repair cost means [Technical Support Fee] + [Part Cost] + [Travelling Expenses]

[Technical Support Fee] is required for diagnosis, repair, replacement or adjustment of parts.

[Part Cost] is the cost of the parts used for repair.

[Travelling Expenses] is required when dispatching certified technician to the location of the product.

Specifications

Model No.		TCB 8200SA / TCB 8200SA (Black)	TCB 8200S / TCB 8200S (Black)
Rated Voltage		220-2400 V~, 50/60Hz	
Rated Power Consumption		1200-1400W	
Power Cord Length		1.2m (4ft)	
Toilet	Water Consumption	Full flush : 4.2L/1.12GPF(For 35 PSI) / Small flush : 3.8L /1.0GPF	
	Flushing System	Siphon jet, Tornado flushing	
Wash Unit	Posterior Wash	Max 540cc / min	
	Feminine Wash	Max 1100cc / min	
	Turbo Wash	Max 640cc / min	
	Water Temperature	Adjustable, 34°C ~ 40°C / 93.2°F ~ 104°F	
	Water Tank	600cc	
	Heater Capacity	1100W	
	Safety Device	Thermal cutoff, Overheating prevention circuit, Temperature sensor	
Heated Seat	Seat Temperature	Adjustable, 34°C ~ 40°C / 93.2°F ~ 104°F	
	Heater Capacity	55W	
	Safety Device	Thermal cutoff, Temperature sensor	
Dry	Hot Air Temperature	Adjustable, 40°C ~ 59°C / 104°F ~ 138.2°F	
	Heater Capacity	250W	
	Safety Device	Thermal cutoff, Temperature overheat preventer (manual recovery bimetal)	
Lighting		UV LED Light	
Auto Lid		Auto Lid	—
Water Pressure		Min : 1.5kgf/cm ² (0.15Mpa) [with 20ℓ/min flow] Max : 7.5kgf/cm ² (0.75Mpa)	
Waterproof rating		IPX4(Seat)	
Inlet water Temperature		5°C ~ 35°C / 41°F ~ 95°F	
Ambient Temperature		5°C ~ 40°C / 41°F ~ 104°F	
Dimension		W 390 mm x L 660 mm x H 545 mm / W 15.3in x L 25.9in x H 21.4in	
Weight		43.5kg [Bidet 6.5kg, Toilet 37kg] 95.9lb [Bidet 14.3lb, Toilet 81.5lb]	43kg [Bidet 6kg, Toilet 37kg] 94.7lb [Bidet 13.2lb, Toilet 81.5lb]

WEEE Directive



This marking shown on the product or its literature, indicates that it should not be disposed with other household wastes at the end of its working life. To prevent possible harm to the environment or human health from uncontrolled waste disposal, please separate this from other types of wastes and recycle it responsibly to promote the sustainable reuse of material resources.

Household users should contact either the retailer where they purchased this product, or their local government office, for details of where and how they can take this item for environmentally safe recycling.

Business users should contact their supplier and check the and conditions of the purchase contract. This product should not be mixed with other commercial wastes for disposal.

Limited Warranty

The product is warranted for one year according to the description written in this warranty.

Please submit this warranty card to local dealer or service center.

Model :	Serial Number :	
Purchaser		
Company :		
Address :		
City :	Country :	
Phone :	Fax :	E-mail :
Dealer(Company)		
Address :		
Installation Date :	Warranty period	
	1 year from purchase date for upper seat 3 years from purchase date for ceramic toilet bowl	

Complete the above warranty card when purchasing the product. Check the information and keep it safe.

Pay Repair Regulations

1. Defects and/or malfunctions from failure to properly install, operate and/or maintain the unit in accordance with the installation manual.
2. Damage from abuse, fire, flood, freeze, and any other acts of nature.
3. Damage resulting from unauthorized alterations, attachments and/or repairs.
4. If the product was not installed properly for residential use.
5. Damage from installing the unit in an environment with animals, mice or insects.
6. Damage caused by excess moisture or from water clogging the water closet.
7. Damage from not being installed in accordance with all applicable local codes, ordinances and good trade practices.
8. Color fading due to use in wrong environments.
9. Damage from consumable chemicals.
10. The warranty will not be covered without providing the date of purchase with original receipt.
11. Damage from misuse due to not following the installation manual.



VOVO WARRANTY

ONE YEAR LIMITED WARRANTY FOR UPPER BIDET SEAT

THREE YEARS LIMITED WARRANTY FOR CERAMIC TOILET BOWL

1. VOVO is proud to guarantee all our products with the longest, most complete coverage warranty in the electronic bidet world. Our policies are written in more detail below.

2. This warranty does not apply to the following items:

- a. Damage or loss sustained in through any natural or man-made caused beyond the control of VOVO including to fire, earthquake, flood, thunder, electrical storm, etc.
- b. Damage or loss resulting from any accident, unreasonable use, misuse, abuse, negligence, or improper care, cleaning, or maintenance of the Product.
- c. Damage or loss resulting from sediments or foreign matter contained in a water system.
- d. Damage or loss resulting from improper installation or from installation of the Product in a harsh and/or hazardous environment, or improper removal, repair or modification of the Product. (NOTE: Product model codes allow a maximum of 80 PSI. Check local codes or standards for requirements).
- e. Damage or loss resulting from electrical surges or lightning strikes or other acts which are not the fault of VOVO or which the Product is not specified to tolerate.
- f. Damage or loss resulting from normal and customary wear and tear, such as gloss reduction, scratching or fading over time due to cleaning practices, water or atmospheric condition, including but not limited to, the use of bleach, alkali, acid cleaners, dry (powder) cleaners or any other abrasive cleaners or the use of metal or nylon scrubbers.
- g. The use of any Product in a manner inconsistent with the Product instructions / owners manual.

3. In order for this limited warranty to be valid, proof of purchase is required. VOVO encourages warranty registration upon purchase to create a record of Product ownership at <http://www.vovouusa.com> Product registration is completely voluntary and failure to register will not diminish your limited warranty rights.

4. THIS WARRANTY GIVES YOU SPECIFIC LEGAL RIGHTS. YOU MAY HAVE OTHER RIGHTS WHICH VARY FROM STATE TO STATE, PROVINCE TO PROVINCE OR COUNTRY TO COUNTRY.

5. To obtain warranty repair service under this warranty, you must take the Product or deliver it prepaid to a VOVO service facility together with proof of purchase (original sales receipt) and a letter stating the problem, email to support@vovouusa.com.

WARNING! VOVO shall not be responsible or liable for any failure of, or damage to, this Product caused by either chloramines in the treatment of public water supply or cleaners containing chlorine (Calcium Hypochlorite).

NOTE: The use of high concentrate chlorine or chlorine related products can seriously damage the fittings. This damage can cause leakage and serious property damage.

THIS WRITTEN WARRANTY IS THE ONLY WARRANTY MADE BY VOVO. REPAIR, REPLACEMENT OR OTHER APPROPRIATE ADJUSTMENT AS PROVIDED UNDER THIS WARRANTY SHALL BE THE EXCLUSIVE REMEDY AVAILABLE TO THE ORIGINAL PURCHASER. VOVO SHALL NOT BE RESPONSIBLE FOR LOSS OF THE PRODUCT OR FOR OTHER INCIDENTAL, SPECIAL OR CONSEQUENTIAL DAMAGES OR EXPENSES INCURRED BY THE ORIGINAL PURCHASER, OR FOR LABOR OR OTHER COSTS DUE TO INSTALLATION OR REMOVAL, OR COSTS OF REPAIRS BY OTHERS, OR FOR ANY OTHER EXPENSE NOT SPECIFICALLY STATED ABOVE. IN NO EVENT WILL VOVO'S RESPONSIBILITY EXCEED THE PURCHASE PRICE OF THE PRODUCT. EXCEPT TO THE EXTENT PROHIBITED BY APPLICABLE LAW, ANY IMPLIED WARRANTIES, INCLUDING THAT OF MERCHANTABILITY OR FITNESS FOR USE OR FOR A PARTICULAR PURPOSE, ARE EXPRESSLY DISCLAIMED. SOME STATES DO NOT ALLOW LIMITATIONS ON HOW LONG AN IMPLIED WARRANTY LASTS, OR THE EXCLUSION OR LIMITATION OF INCIDENTAL OR CONSEQUENTIAL DAMAGES, SO THE ABOVE LIMITATION AND EXCLUSION MAY NOT APPLY TO YOU.

MEMO

MEMO



Inquiry : support@vovousa.com